

EXHIBITION APPLIANCES CATALOGUE

 **Pavilions**
and
Interiors
india private limited



A-63, Sector 57, Noida (UP) Ph: 951202581217-18 Fax: 951202581215

**DELHI, MUMBAI, KOCHI, KOLKATA,
BANGALORE & COIMBATORE**



PI - 01

Executive Chair



PI - 02

VIP Sofa Single



PI - 03

VIP Sofa Double



PI - 04

VIP Sofa Three Seater



PI - 05

Sofa Seat - Single



PI - 06

Visitor Chair



PI - 07

Sofa Chair



PI - 08

Conference Chair



PI - 09

Wooden Chair & High Stool



PI - 10

Folding Chair



PI - 11

Bar Stool (High)
75cm (H)



PI - 12

Bar Stool (Adjustable)
50cm (H)



PI - 13

Round Table
70cm(Dia) x 75cm(H)

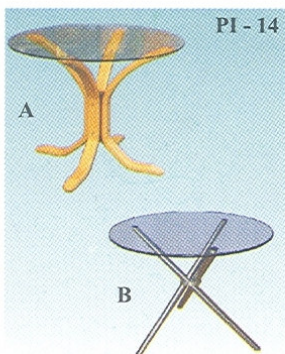

PI - 14

Round Table (Wooden/Cross leg)
90cm(Dia) x 75cm(H)



PI - 15

Round Table
80cm (Dia) x 75 (H)



PI - 16

Glass Counter
100cm(L)x50cm(W)x100cm(H)





PI - 17

Table
105cm(L)x60cm(W)x70cm(H)



PI - 18

Two Level Information Counter
100cm(L)x60cm(W)x110cm&75cm(H)



PI - 19

Side Rack (Lockable)
40cm(L) x 100cm(W) x 60cm(H)



PI - 20

Showcase
50cm(L) x 50cm(W) x 200cm(H)



PI - 21

Showcase
50cm(L) x 100cm(W) x 200cm(H)



PI - 22

Centre Table
120cm (L) x 45cm (W)



PI - 23

Square Table
70cm(L) x 70cm(W) x 70cm(H)



PI - 24

Standing Discussion Table



PI - 25

Podium
50cm(L) x 50cm(W) x 100cm(H)

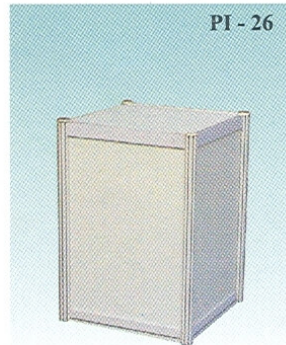

PI - 26

Podium
50cm(L) x 50cm(W) x 70cm(H)

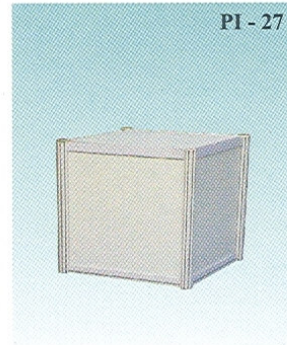

PI - 27

Podium
50cm(L) x 50cm(W) x 50cm(H)



PI - 28

Grid Ceiling
100cm x 100cm



PI - 29

Brochure Rack

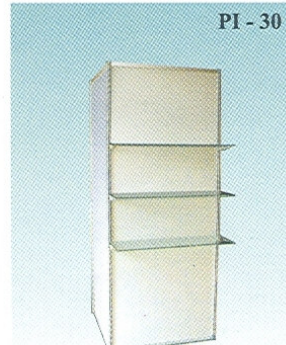

PI - 30

Glass Shelf Set of Three

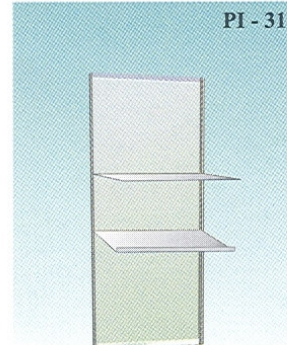

PI - 31

Wooden Shelf Flat/Adjustable

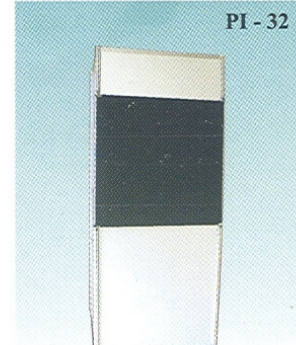

PI - 32

Pin-Up Board with Grey Fabric



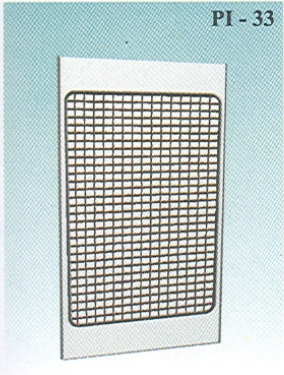

PI - 33

Wire Mesh with Hooks

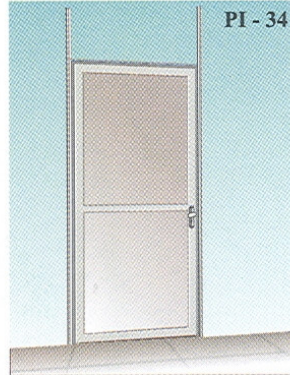

PI - 34

Lockable door

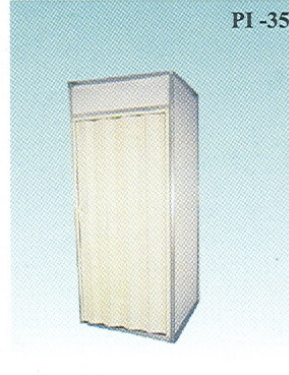

PI - 35

System Folding Door

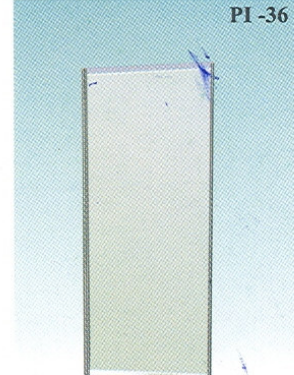

PI - 36

System Panel

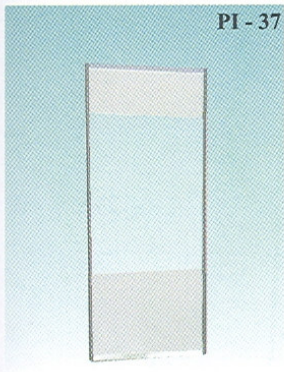

PI - 37

Glass Wall

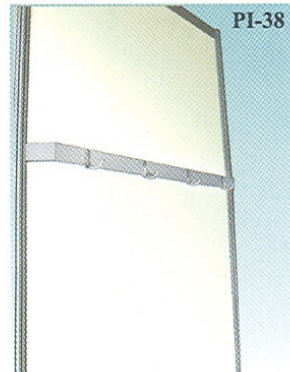

PI-38

Wall Coat Hanger

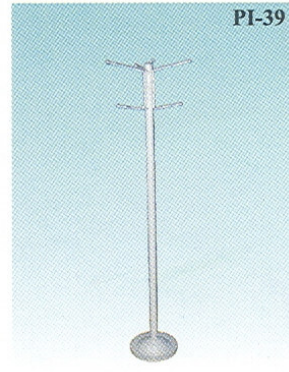

PI-39

Coat Hanger Self Standing

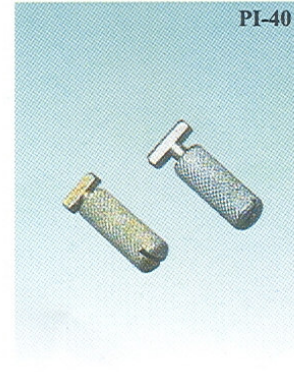

PI-40

T - Bolts

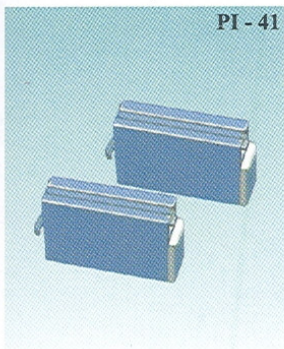

PI - 41

Graphic Retainer

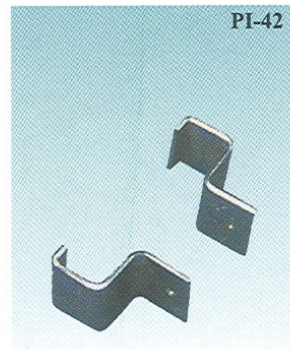

PI-42

Photo Clip

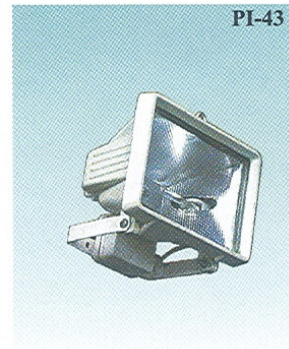

PI-43

Halogen Lamp

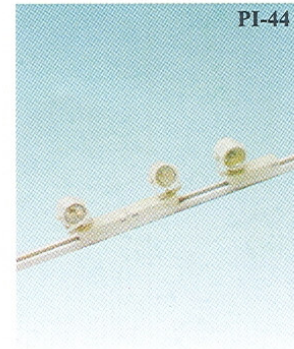

PI-44

Track Light

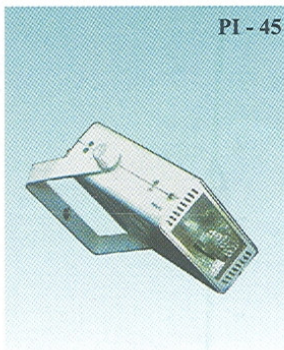

PI - 45

Metal Halide



PI-46

Ceiling Down Light



PI-47

Spotlight

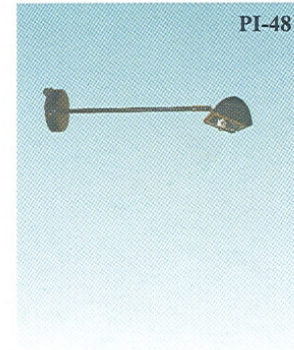

PI-48

Long Arm Halogen Light

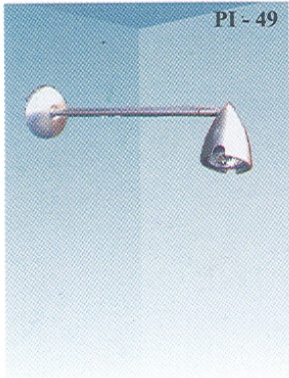

Arm Light



Fridge - 165 Ltr.



Fridge-90Ltr

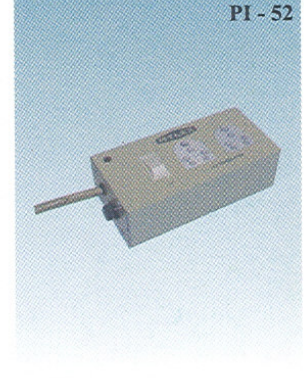

Power Socket 5 A/15A



Coffee Machine



Water Dispenser

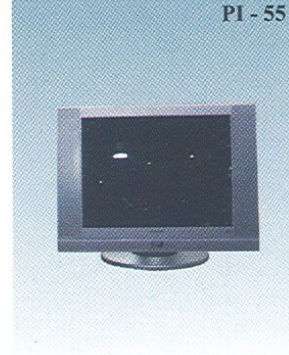

LCD TV

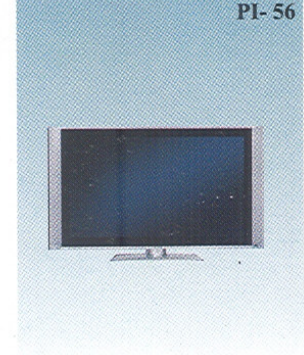

Plasma 42"



Plasma 50"



17" TFT Monitor



LCD Projector



PC with Multimedia

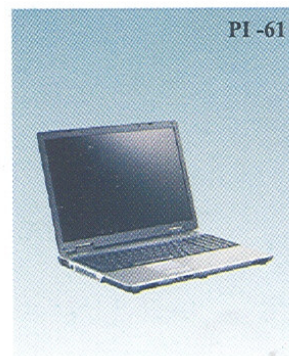

Laptop



Sink Unit



Waste Bin

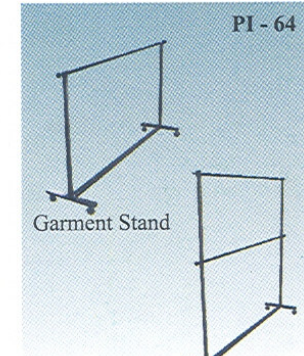

Garment Stand Adjustable-



redefining the paradigms of exhibitions ...



Conceptualisation to inspirational designs and fabrication of these
into aesthetically functional creations, Exhibitions-Exteriors,
Interiors, Museums, Retailing and Road Shows



Pavilions
and
Interiors

india private limited

www.pavilionsinteriors.com

NOIDA : A-63, SECTOR-57, NOIDA - 201301 (U.P) Ph: +95-120-2581217, 2581218, 2581119 Fax : 95-120-2581215
NEW DELHI : I-40, LAJPAT NAGAR-III, NEW DELHI - 110 024 Ph: +91-11-29834413, 29844344 Fax: 91-11-29834388. e-mail :
pinoida@pavilionsinteriors.com MUMBAI : Ph : +91-22-24314891, 24322190, 56661338, 56661339 Fax: +91-22-24362872 KOCHI : Ph : 0484-2355324,
2351832 Fax : 2351838 KOLKATA : Ph : 033-39518521 Fax : 033-23219205 BANGALORE : Mobile : 09845108042

HANDLES PROJECTS ALL OVER INDIA AND ABROAD

PAVILIONS AND INTERIORS (I) PVT.LTD.

EXTRA FURNITURE RATE LIST.

Sr.No	Code No	Name of the product	Rate
<u>1</u>	PI 01	Executive Chair	1500
<u>2</u>	PI 02	Vip Sofa Single	2500
<u>3</u>	PI 03	Vip Sofa Double	3500
<u>4</u>	PI 04	Vip Sofa Three Seater	5000
<u>5</u>	PI 05	Sofa Seat - Single	2000
<u>6</u>	PI 06	Visitor Chairs	400
<u>7</u>	PI 07	Sofa Chairs	1200
<u>8</u>	PI 08	Conference Chairs	800
<u>9</u>	PI 09	Wooden Chairs & High stool	800
<u>10</u>	PI 10	Folding Chair	250
<u>11</u>	PI 11	Bar Stool (High) 75 cm	950
<u>12</u>	PI 12	Bar Stool (Adjustable) 50 cm	650
<u>13</u>	PI 13	Round Table 70cm(Dia) x 75cm (H)	800
<u>14</u>	PI 14	Round Table (Wooden /Cross Leg) 90cm(Dia) x 75cm (H)	1500
<u>15</u>	PI 15	Round Table 80cm(Dia) x 75cm (H)	1200
<u>16</u>	PI 16	Glass Counter 100cm (L) x 50cm (W) x 100 cm (H)	2000
<u>17</u>	PI 17	Table 105 cm(L) x 60cm (W) x 70 cm (H)	800
<u>18</u>	PI 18	Two Level Information Counter 100 cm(L) x 60cm (W) x 75 cm (H)	2000
<u>19</u>	PI 19	Side Rack (Lockable) 40 cm(L) x 100cm (W) x 60 cm (H)	2500
<u>20</u>	PI 20	Showcase 50 cm(L) x 50cm (W) x 200 cm (H)	3000
<u>21</u>	PI 21	Showcase 50 cm(L) x 100cm (W) x 200 cm (H)	3500
<u>22</u>	PI 22	Centre Table 120 cm(L) x 45 cm (H)	900
<u>23</u>	PI 23	Square Table 70 cm(L) x 70cm (W) x 70 cm (H)	800
<u>24</u>	PI 24	Standing Discussion Table	1500
<u>25</u>	PI 25	Podium 50 cm(L) x 50cm (W) x 100 cm (H)	1200
<u>26</u>	PI 26	Podium 50 cm(L) x 50cm (W) x 70 cm (H)	1000
<u>27</u>	PI 27	Podium 50 cm(L) x 50cm (W) x 50 cm (H)	900
<u>28</u>	PI 28	Grid Ceiling 100cm x 100cm	1500
<u>29</u>	PI 29	Brochure Rack	900
<u>30</u>	PI 30	Glass Shelf Set of Three	1500
<u>31</u>	PI 31	Wooden Shelf Flat / Adjustable	750
<u>32</u>	PI 32	Pin up board with grey fabric	1000
<u>33</u>	PI 33	wire Mesh with Hooks	1500
<u>34</u>	PI 34	Lockable Door	3000
<u>35</u>	PI 35	System Folding Door	5000
<u>36</u>	PI 36	System Panel	1200
<u>37</u>	PI 37	Glass Wall	4000
<u>38</u>	PI 38	Wall Coat Hanger	450
<u>39</u>	PI 39	Coat Hanger Self Standing	1500
<u>40</u>	PI 40	T- Bolts	30
<u>41</u>	PI 41	Graphic retainer	30
<u>42</u>	PI 42	Photo Clip	20
<u>43</u>	PI 43	Halogen Lamp	600
<u>44</u>	PI 44	Track Light(Four Light)	1300
<u>45</u>	PI 45	Metal Halide	1200

<u>46</u>	PI 46	Ceiling Down Light	350
<u>47</u>	PI 47	Spot Light	300
<u>48</u>	PI 48	Long Arm Halogen Light	1200
<u>49</u>	PI 49	Arm Light	500
<u>50</u>	PI 50	Fridge	5000
<u>51</u>	PI 51	Fridge	4500
<u>52</u>	PI 52	Power Socket 5 A / 15 A	250
<u>53</u>	PI 53	Coffee Machine	5500
<u>54</u>	PI 54	Water Dispenser	1000
<u>55</u>	PI 55	LCD T.V	2500
<u>56</u>	PI 56	Plasma 42"	5000
<u>57</u>	PI 57	Plasma 50"	7000
<u>58</u>	PI 58	17" TFT Monitor	1000
<u>59</u>	PI 59	LCD Projector	3500
<u>60</u>	PI 60	PC with Multimedia	1500
<u>61</u>	PI 61	Laptop	3000
<u>62</u>	PI 62	Sink Unit	
<u>63</u>	PI 63	Waste Bin	150
<u>64</u>	PI 64	Garment Stand	1500
<u>65</u>	PI 65	Extra panel	1500

Complimentary for Shell Scheme each 9 sqmtr stall		
White powder coated system table		1 nos
Folding Chairs/ Mould chair (new)		2 nos
Spotlights 100 w (powder coated)		3 nos
Plug point 15 amp		1 nos
Waste Paper Basket		1 nos
Fascia with name in computer cut vinyl		1 nos

Note :All Order Should be place 15 days prior thr Event